









# HANGAR

**6x** **(a)** min 7 cm max 9 cm   270 cm



min 7 cm max 9 cm

**2x** **(b)** min 7 cm max 9 cm   195 cm



min 7 cm max 9 cm

**4x** **(c)** min 7 cm max 9 cm   170 cm



min 3,5 cm max 5 cm

**5x** **(d)** min 7 cm max 9 cm   150 cm



min 3,5 cm max 5 cm

**4x** **(e)** min 7 cm max 9 cm   120 cm



min 3,5 cm max 5 cm

**2x** **(f)** min 7 cm max 9 cm   75 cm



min 3,5 cm max 5 cm

**2x** **(g)** min 7 cm max 9 cm   60 cm



min 3,5 cm max 5 cm

**1x** **(h)** min 7 cm max 9 cm   54 cm

min 3,5 cm max 5 cm



**8x** **(i)** min 7 cm max 9 cm   50 cm

min 3,5 cm max 5 cm

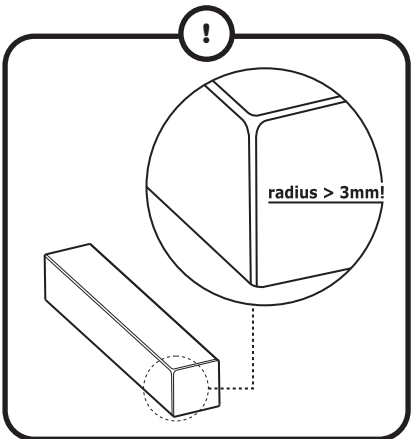

**2x** **(j)** min 7 cm max 9 cm   20 cm

min 3,5 cm max 5 cm





**21/30x** **(k)** min 9 cm max 14 cm   150 cm



min 1,6 cm max 2,2 cm

**4x** **(l)** min 9 cm max 14 cm   120 cm

min 1,6 cm max 2,2 cm

**11/17x** **(m)** min 9 cm max 14 cm   102/107 cm

min 1,6 cm max 2,2 cm

**17/26x** **(n)** min 9 cm max 14 cm   60 cm

min 1,6 cm max 2,2 cm